

Article number: 20192B42B42652BL

Description: E+G

T-angle clamps GN192-B42-B42-65-2-BL

## Measures

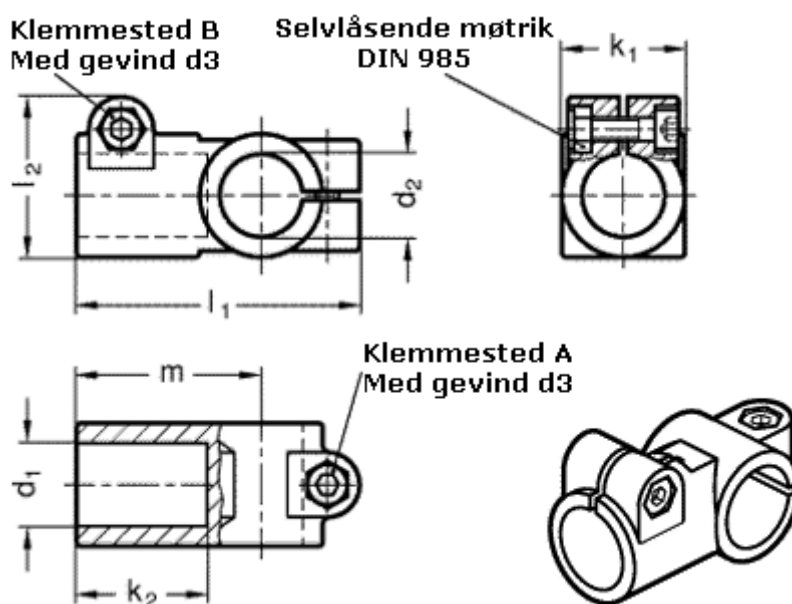

d1 = B42  
d2 = B42  
d3 = M10  
k1 = 65  
k2 = 75.0  
l1 = 148  
l2 = 77.5  
m = 103